

L3PRO User Manual

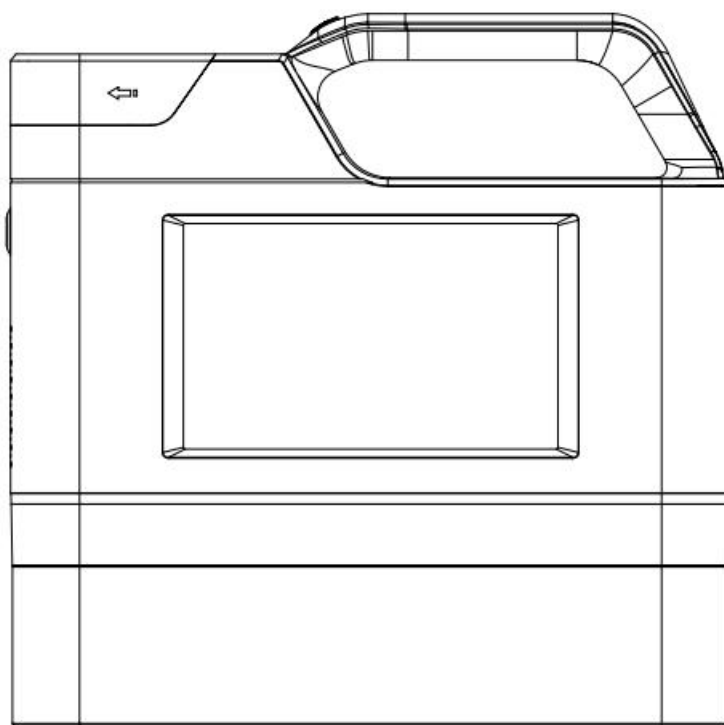

Please read this manual carefully to use the product in better performance

WARNING AND NOTE:

1. Do not use laser to irradiate human eyes or other parts.
2. Do not stare at the laser light point for a long time, so as not to damage the eyes.
3. When the machine is not working, please turn off the power.
4. Be sure to shut down the machine according to the operation steps when shutting down the machine: Click the shutdown button → select "Yes" → wait for the screen to turn black → turn off the power switch.
5. Please do not put the machine in a humid environment, so as not to be affected by the machine.
6. When cleaning the machine, keep away from water and do not use chemical solvents for cleaning.
7. Please don't hit the machine with anything hard.
8. Do not remove or insert the battery at will.
9. Try to avoid sculpting while charging.

Common problems and ways of handling

Cannot be carved or unclear

- 1) Please check if the power is sufficient;
- 2) Please check if printing parameters are set correctly;
- 3) Please check if the bottom baffle is blocking;
- 4) Please check if other printing parameters are set correctly;
- 5) Please check if the focal length is correct;

Content

1 Features.....	- 1 -
2 Technical Parameter.....	- 1 -
3 Interface.....	- 2 -
3.1 Main interface.....	- 2 -
3.2 File save interface.....	- 2 -
4 File Management.....	- 3 -
4.1 Edit text.....	- 3 -
4.2 Edit date and time.....	- 3 -
4.3 Edit picture.....	- 3 -
4.4 Edit BAR code.....	- 3 -
5 Parameter management.....	- 5 -
5.1 System settings.....	- 5 -
6 System settings.....	- 6 -

Dear Customer:

Thank you for purchasing and using the handheld laser marking machine!
To better understand, master and use this machine, please read the user manual carefully, it will bring you convenient, fast and correct operating procedures, otherwise a small mistake or irregular operation may bring the unnecessary trouble.

1 Features

- >Semiconductor laser head (Blu-ray)
- >Single-core industrial grade CPU
- >50mm * 50mm Marking Area
- >Large-capacity lithium battery: 7.4V 8550mAh

2 Technical Parameter

Operation System: Linux

CPU: Quad-core, 1.4GHz

Communication Interface: USB

Language: Simple Chinese, Traditional Chinese, English, etc

Marking Distance: Best marking quality at 50mm

Marking Speed: 100 levels adjustable,1% 400us each point, 1% 400us each point

Laser Intensity: 100 levels adjustable, maximum power 18.2W

Laser Source Life: 8000 hours

Marking Content: Chinese, English, number, symbol, QR code, barcode, picture and date

Marking Material: wooden board, cardboard, plastic, leather, etc.

Battery: 8550mAh lithium battery pack (7.4V <=5A)

Adapter: Input 100~240V AC, Output 8.4V 4A/5A DC

Dimension: 207*66*208mm (H*W*D)

Weight: 2.5KG(with battery)

Temperature: 0 - 65 degree(best at 20-30); Humidity: 40% - 60%Rh

3 Interface

3.1 Main interface

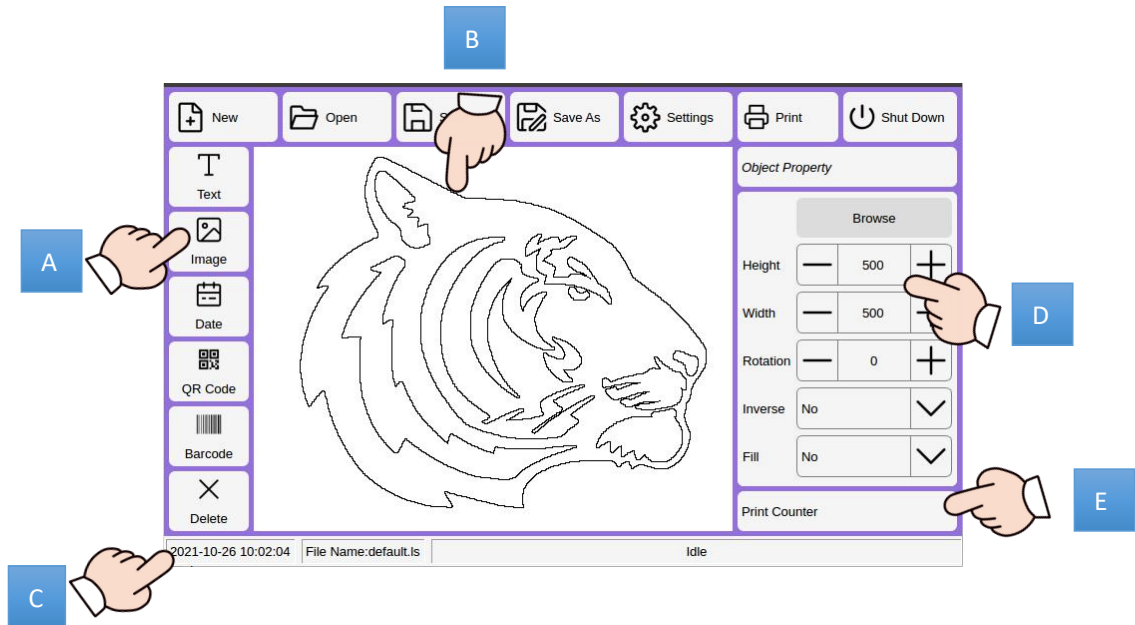

- A: Editable options, displayed on B when clicked.**
- B: Visual window, the displayed content is the marked content.**
- C: System date and time.**
- D: Editable options, parameter adjustment options.**
- E: System setup options and print options.**

3.2 File save interface

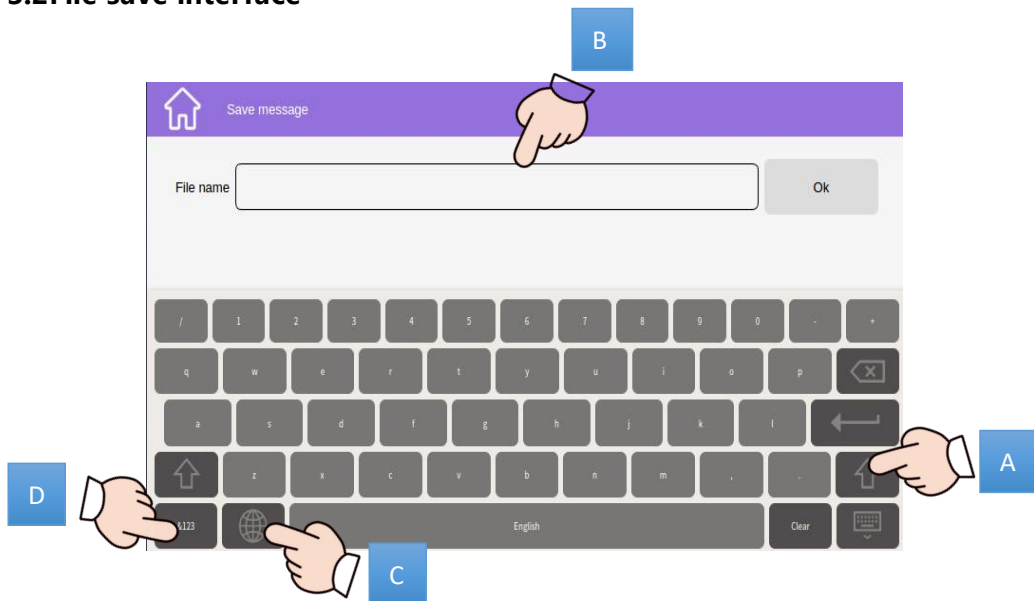

- A: "↑" Caps lock**
- B: File name**

C: "  " Chinese and English switching



D: "&123" Symbol and number switching

4 File Management

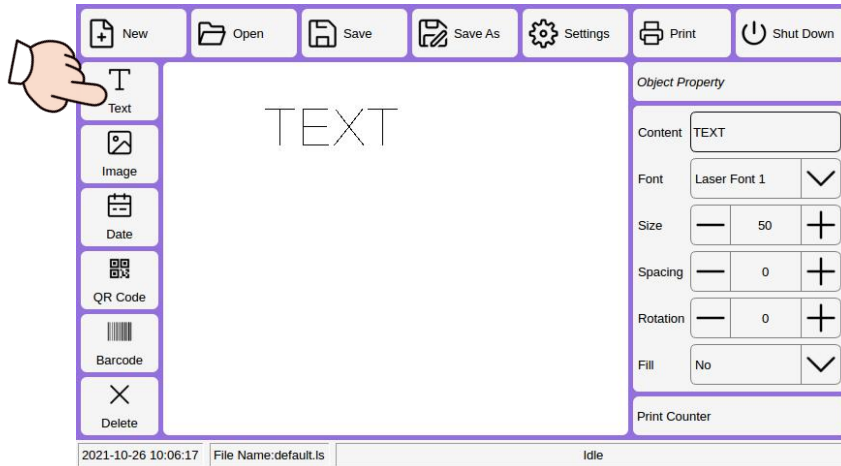
4.1 Edit text



Click "Text" → "Content" → "Clear" → input the information you need → "Finish" → adjust the font, size as needed → move the information in the center of the white blank → "File" → "Save or Save As" → input the file name → "OK" The editing is complete.

Note: "  " Chinese and English switching, "  " Caps lock, "&123" Symbol and number switching

4.2 Edit date and time

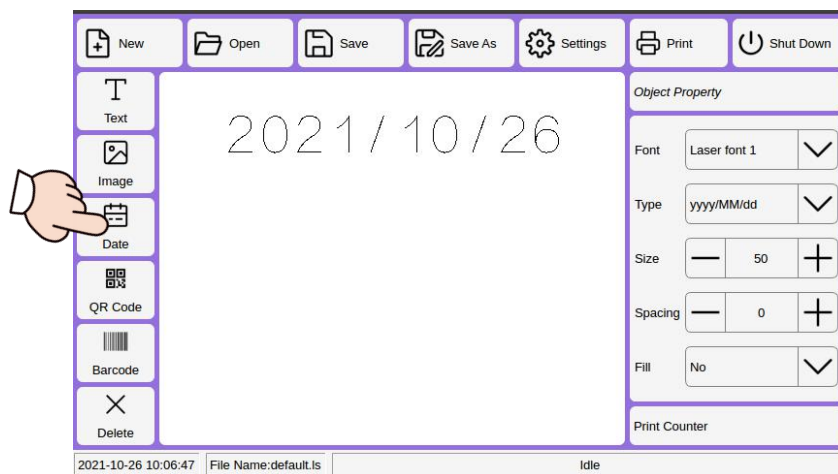

Click Time (windows will pop up system time)→ click User-defined to set time format as need
→ OK → File → Save or Save As.not be edited with the keyboard. If you need to set the specified time, you can use text editing or modify the system time.

Note: Click "Type" to quickly select the time format. The time information cannot be edited using the keyboard. If you need to set the specified time, you can edit the text or change the system time.

4.3Edit image (BMP)

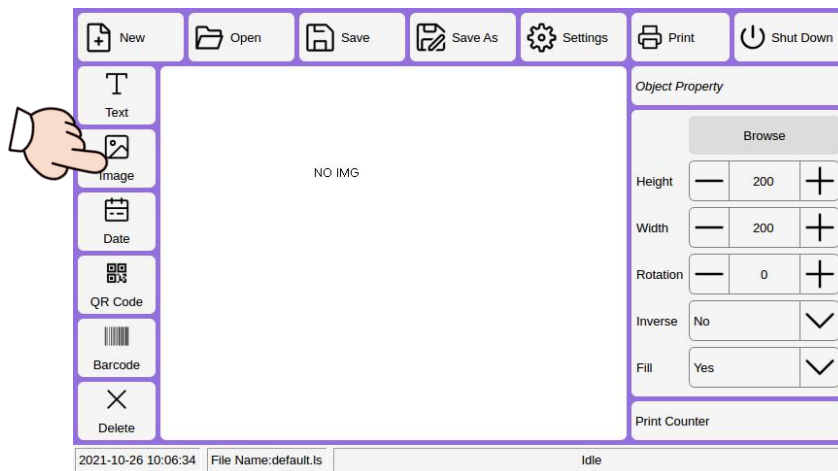

(Insert U disk) Click "Image" → "Replace" → "U disk" → select "file" → copy to local → "local file" (select the file copied to the previous step) → "OK" → The window will display the selected picture → formatting is completed as required. Or use Save As to change the file name.

The picture should be named after "numbers or English", do not use Chinese and special symbols to display garbled characters.

4.4Edit bar code



Click "Bar code" → the window will display the default barcode → "Keyboard" → "Empty" → enter the required information → "Finish" → " Save " → enter a file name, select a save location, and click "OK" .**Note: Note: Barcode cannot use Chinese information.**

4.5 Edit QR code

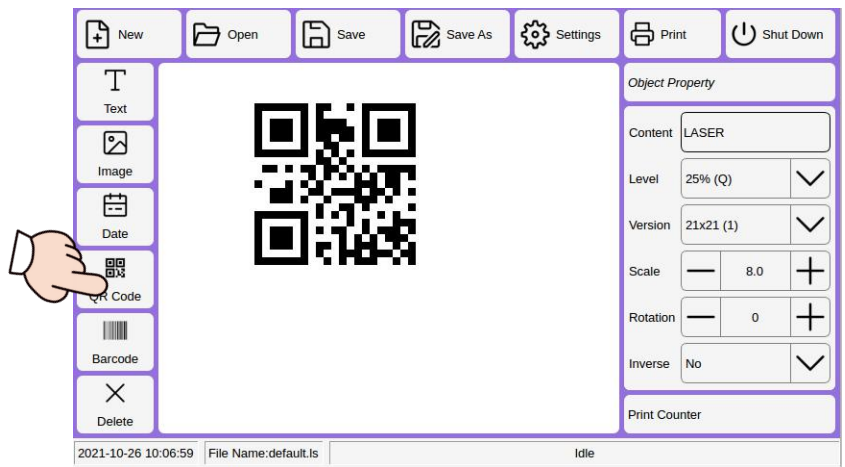

Click "QR code" → white window will display the default QR code → "content" → "clear" → enter the required information → "finish" → "save" → enter File name, select the save location, and click "OK" .

Note: The size of the QR code can be adjusted by "Scale", and the relusion can be adjusted by "Precision".

5 Parameter management

5.1 System settings

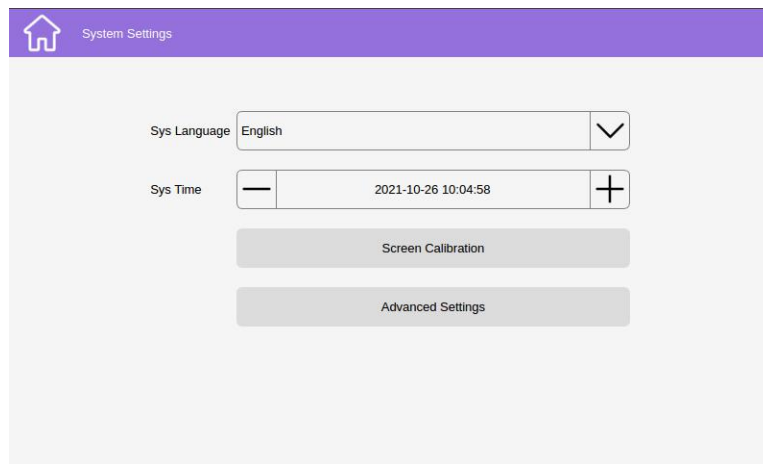

1. System language: select a language.

2. System time: current date and time.

3. advanced settings: customized function reserved interface.

4. Return:  return to home interface and save parameter.

6 Packing List

No.	Item	Quantity
1	Handheld marking machine	1
2	Shading cover	1
3	Power adapter	1
4	U disk	1
5	User manual	1
6	Touch pen	1

7 Case shows

