



LASER

Laser Marking Machine



Wuhan Xiantong Technology Co., Ltd.

Web : www.meenjet.net

Email : info@meenjet.net

MFS Series

Static Fiber Laser Marking



- ① Excellent MTBF laser source life of up to 100,000 hours
- ② Air-cooled laser source requires virtually no maintenance

- ③ No wearing parts, minimizing downtime
- ④ Permanent coding helps ensure product traceability and prevents tampering



Metal pipe



Wood



Metal part



Aluminum can

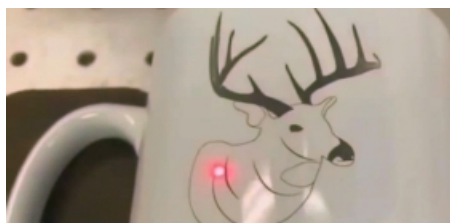

Ceramic cup











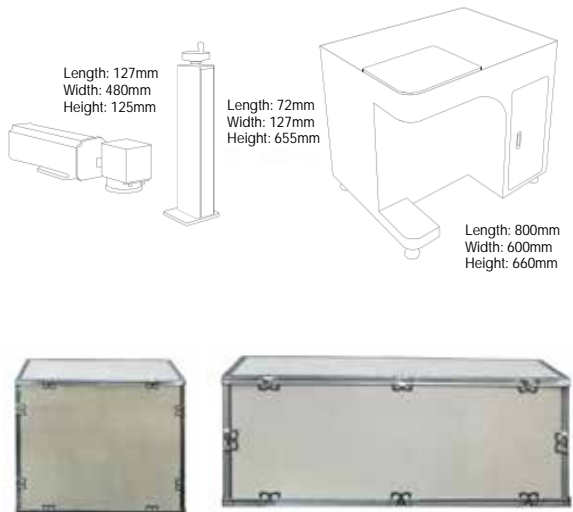

Plastic tag

Parameters

Model	MFS20	MFS30	MFS50
Laser Source	Fiber laser		
Power	≥ 20W	≥ 30W	≥ 50W
Wavelength	1064nm		
Marking Speed	≤ 12000mm/s		
Focus Indicator	Dual red light focusing		
Cooling System	Air-cooling		
Power Supply	110V/220V, 50HZ/160HZ 500W		
Operating Environment	Temperature: 0-45°C ; Humidity: <95%, non-condensing		
Operating System	Windows		
Controller	PC		
Marking Range	110*110mm (Optional: 110~300mm)		
Language	Arabic, German, Greek, English, Spanish, Persian, French, Italian, Japanese, Korean, Portuguese, Russian, Thai, Turkish, Vietnamese, Simplified Chinese, Traditional Chinese, etc. (support language customization)		
Printing Content	Content: text, date, logo, graphic, barcode, OR code, etc. Barcode: CODE39, CODE128, CODE126, UPC-A.UPC-E, EAN-13.EAN-8		
Suitable Material	Stainless steel, iron, copper, aluminum, titanium, silver, ABS, PVC, PE, rubber, wood, leather, etc.		
Applications	Building materials industry, cosmetics industry, hardware industry, auto parts industry, electrical appliance industry, jewelry DIY, personalized gift customization, etc.		

Dimension & Accessories



Standard List			
 ① Static cabinet	 ② Display screen	 ③ Lifting platform	
 ④ Power cable	 ⑤ Tool kit	 ⑥ Laser host	 ⑦ Positioning plate
Optional Parts		 ① Rotating table	 ② Foot switch